

# Setting Up Your Dell PowerVault MD3260/3260i/3660i/3660f/3060e Storage Array



## Racking Your Storage Enclosure

**WARNING:** Before you set up and operate your Dell PowerVault system, review the safety instructions that shipped with your system.

### Verify Storage Array Components

Your system is shipped with RAID controller modules, power supplies, and fan components already installed in the enclosure. Make sure that all components are properly seated and have not become dislodged and/or damaged during shipping.

### Install the Enclosure in a Rack

The storage enclosure requires a compatible rack and a rack installation kit. For information about installing the rails for the storage enclosure, see the Rack Installation instructions that shipped with your enclosure.

**WARNING:** Do not plug the enclosure into a standard power outlet. Your storage array is shipped with two IEC C19 to C20 jumper cords. Plug the C19 plug into the array's power supplies and the C20 plug into the power distribution unit (PDU) in the rack cabinet. For power redundancy, split the PDU connections from each enclosure into separate PDUs and connect the PDUs to external power receptacles on different circuits. The enclosure accepts only 200 V to 240 V input sources.

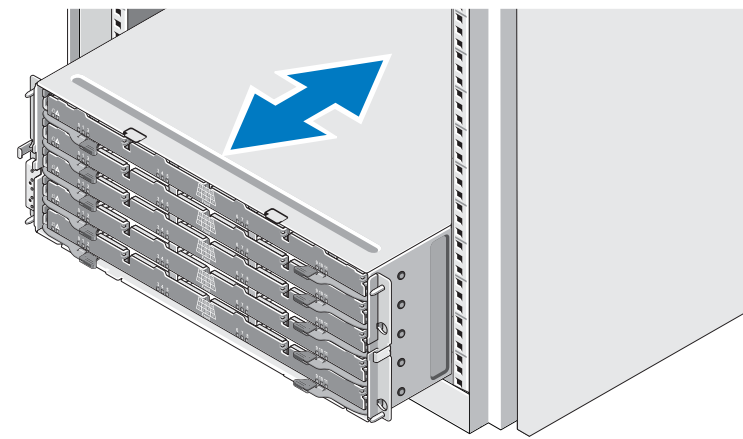

**NOTE:** For safety reasons, do not install physical disks in the enclosure before racking. This will add substantial weight to the enclosure and make lifting and racking the enclosure unsafe. For more information, see the Rack Installation instructions that shipped with your enclosure.

### Locate Your System Service Tag

Your system is identified by a unique Express Service Code and Service Tag number. This information is used by Dell to route support calls to the appropriate personnel.

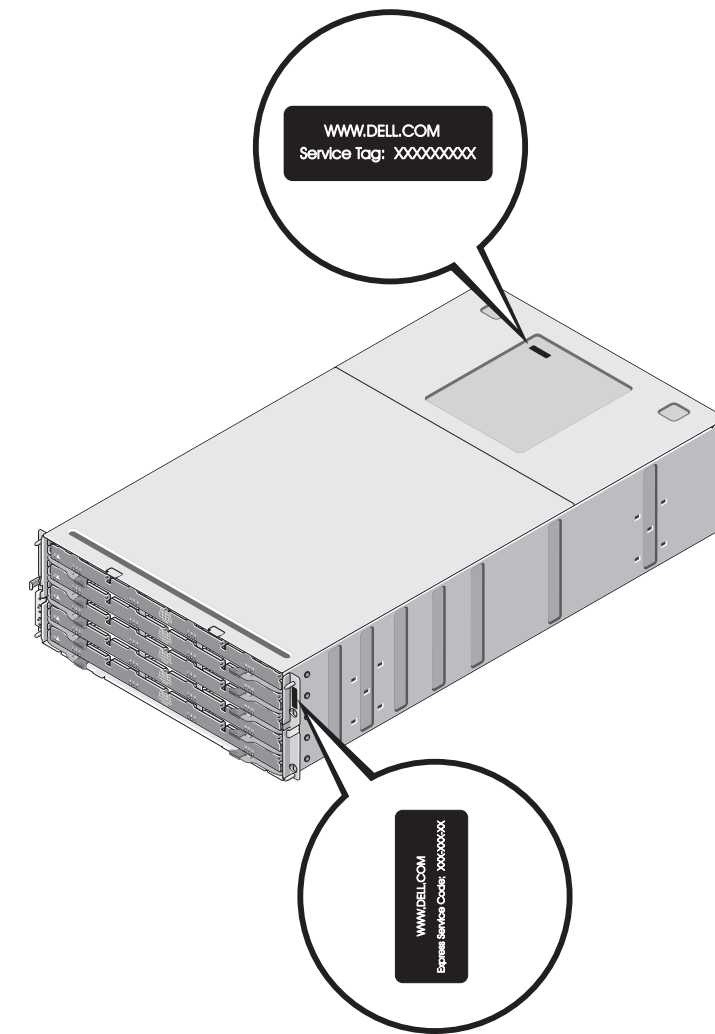

## Physical-Disk Drawers

The MD Series Dense storage enclosure contains five physical-disk drawers accessible from the front of the enclosure. Each drawer holds up to 12 physical disks.

To open a drawer:

1. Flip both latches outward.
2. Pull the drawer out.

**NOTE:** When a drawer is opened, the enclosure cooling fan RPMs increase significantly to ensure optimal airflow. This is normal and not indicative of a problem.

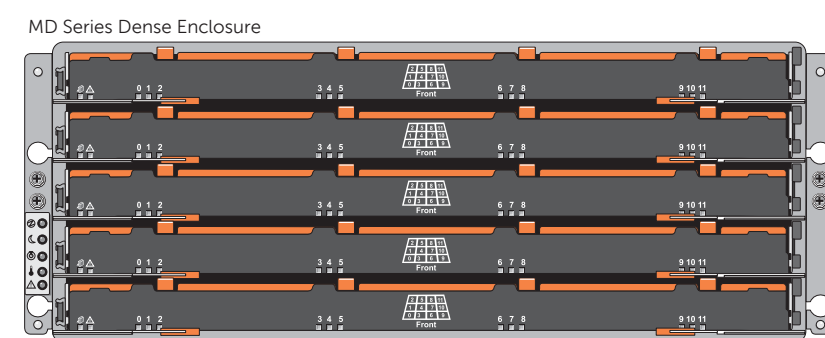

To close a drawer:

1. Push the drawer into the enclosure until the release latch clicks into place.
2. Close the latches on each side of the drawer.

**NOTE:** Ensure that the drawer is pushed in and closed completely.

**CAUTION:** If a drawer is not completely inserted into the enclosure, other drawers will be locked. Do not force a drawer open as it may damage the physical disk or the drawer itself.

## Installing Physical Disks

### Physical-Disk Carriers

Physical disks are preinstalled in their carriers and shipped separately in anti-static packaging and must be installed in the drawers. For information on installing and removing the physical disks from the physical-disk carriers, see your system's Owner's Manual at [support.dell.com/manuals](http://support.dell.com/manuals).

### Physical Disk Installation Guidelines

- To maintain proper airflow, install physical disks from left to right and front to back in each drawer.
- A minimum of four disks must be installed in each drawer, filling slots 0, 3, 6, and 9 first.
- Keep all drawers closed unless you need to access the physical disks. The storage array operates normally with a drawer open, but it is designed for optimal cooling with all drawers closed.

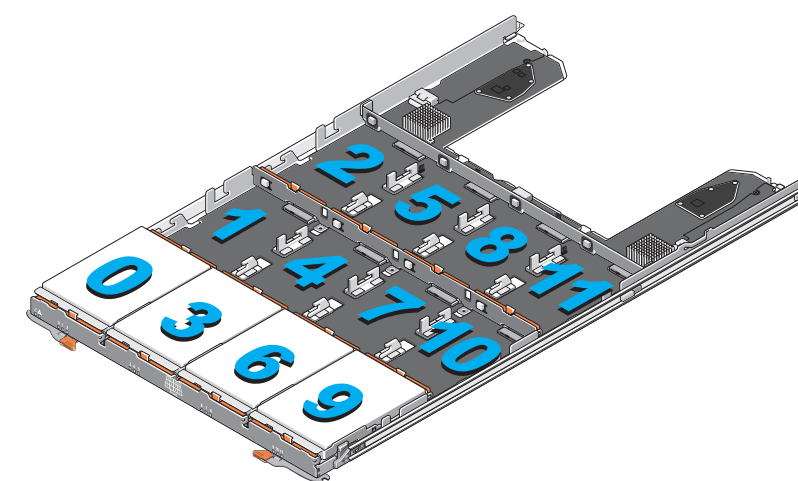

## About the Storage Enclosure

The MD Series Dense storage enclosure is a five-drawer, 60-physical disk chassis (4U) managed by either two RAID controller modules or enclosure management modules (EMMs).

**NOTE:** A single RAID controller or enclosure management module configuration is not supported.

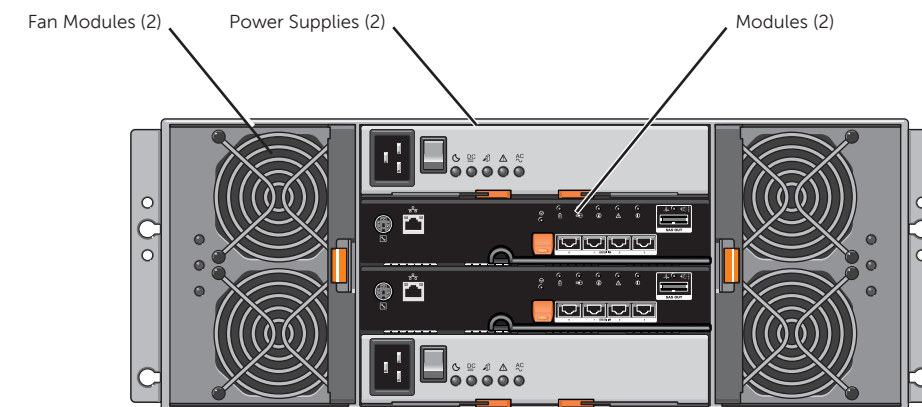

### Expansion Enclosure Management Modules

You can expand the storage capacity of your array by daisy chaining up to two expansion enclosures (for a maximum of 180 physical disks). Each 4U expansion enclosure added must contain two MD3060e EMMs.

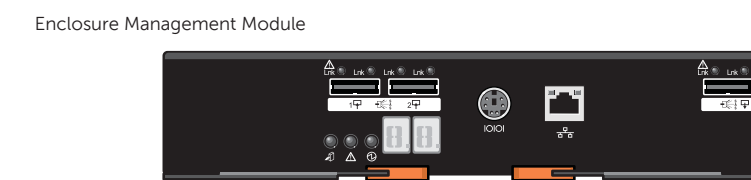

## RAID Controller Modules

The MD Series Dense enclosure supports four different types of RAID controllers. The RAID controllers installed in an enclosure must be of the same data protocol. Mixing of RAID controllers is not supported.

### 6 Gbps SAS RAID Controller Module



### 1 Gbps iSCSI RAID Controller Module

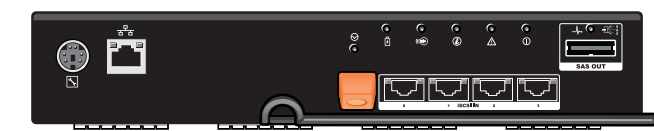

### 10 Gbps iSCSI RAID Controller Module

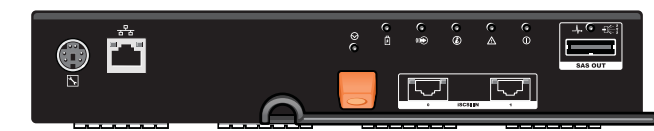

### Fibre Channel RAID Controller Module

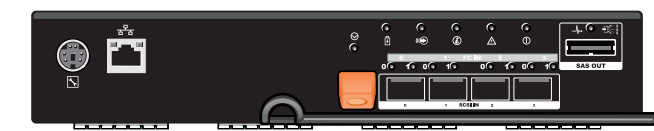

To install a physical disk into a drawer:

1. Rotate the physical disk carrier handle upward to the vertical position.
2. Align the two raised buttons on the disk carrier with the notches on the physical-disk drawer.
3. Lower the physical disk into the drawer slot.  
**NOTE:** Fill disk slots 0, 3, 6, and 9 first. Do not install disks randomly.
4. Rotate the physical disk carrier handle downward until the physical disk is properly seated in the connector and the physical-disk carrier handle snaps into place.  
**NOTE:** Check that the disk is not raised up at the back of the drawer slot, which would indicate that it is not properly seated. Closing the drawer with an improperly seated disk will damage both the drawer and the physical disk.
5. Close the physical-disk drawer.

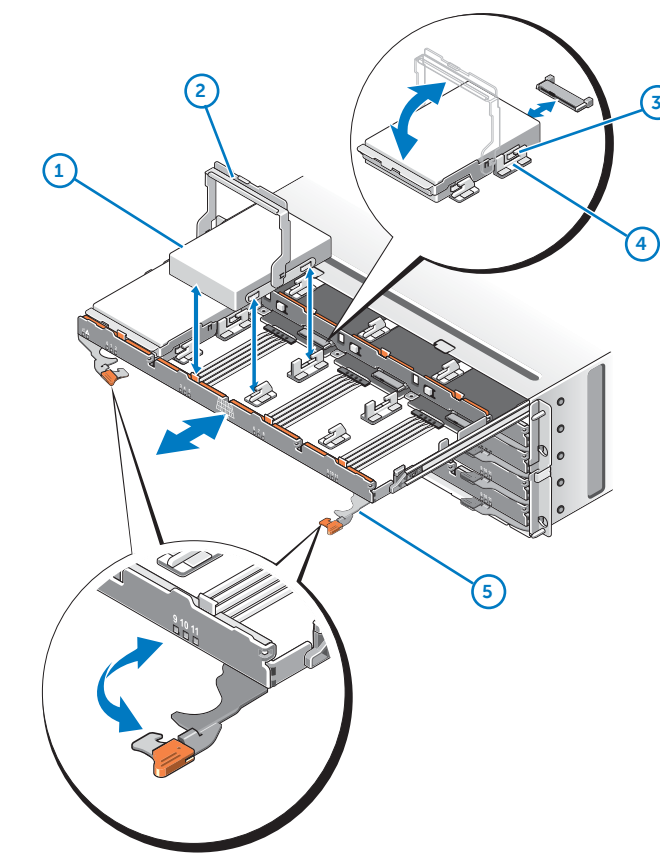

1. physical disk
2. physical-disk carrier handle
3. notches on physical-disk drawers
4. buttons on disk carrier
5. drawer latches (2)



# Setting Up Your Dell PowerVault MD3260/3260i/3660i/3660f/3060e Storage Array (continued...)



## Cabling Your Storage Array and Expansion Enclosure

The MD Series Dense enclosure supports a number of non-redundant (single path) or redundant (dual path) configurations, depending on your storage array model.

For SAS and iSCSI storage arrays, see the corresponding Deployment Guides. For Fibre Channel storage arrays, see *Configuring Fibre Channel With Dell MD3600i/3620i/MD3660i Series Storage Arrays*.

The following sample configurations illustrate basic host server to storage array cabling concepts. Port availability depends on your MD Series model.

### Direct-Attached, Non-Redundant Cabling

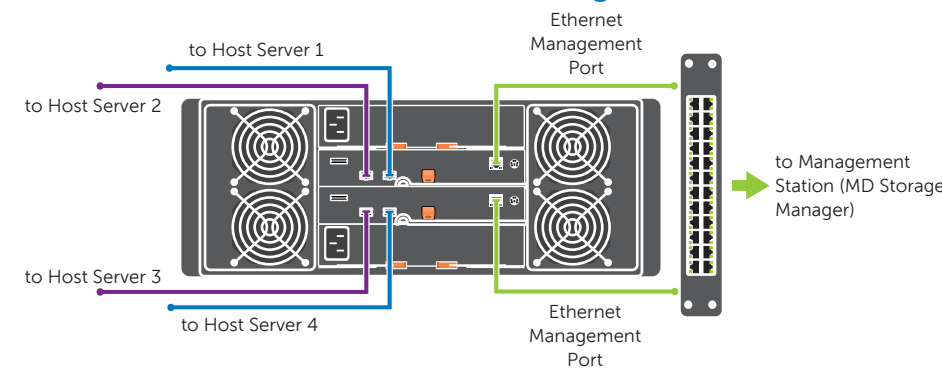

### SAN-Attached, Redundant Cabling

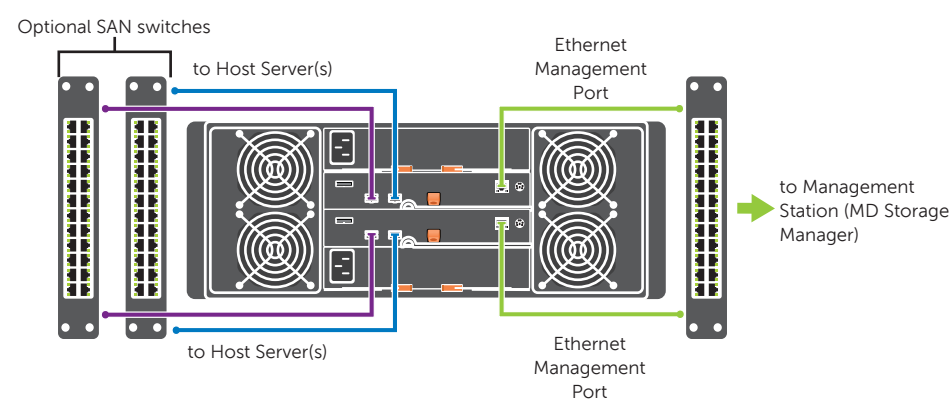

### SAN-Attached Configuration

A supported switch zoning topology is required to deploy the MD3660f Fibre Channel storage array. See *Configuring Fibre Channel With Dell MD3600i/3620i/MD3660i Series Storage Arrays* at [support.dell.com/manuals](http://support.dell.com/manuals).

For highest throughput, all network components (switch, router, host NIC or cable connection) must support the highest storage array data speed. For example, connecting a 10 Gbps iSCSI storage array to a host server using a 1 Gbps network switch will reduce overall throughput.

### Cabling Guidelines

- Always cable your storage array in a powered-down state.
- For Fibre Channel storage arrays, always use a Dell-supported Small Form-factor Pluggable (SFP) transceiver (see the Dell PowerVault Support Matrix at [support.dell.com](http://support.dell.com)).
- Make sure you understand data availability and failover requirements for your configuration before cabling the storage array.
- Only use Dell MD 3060e expansion enclosure to expand the capacity of your storage array.

### Cabling Your MD3060e Expansion Enclosure

To add capacity to your Dense storage array, you can daisy chain up to two 4U enclosures with SAS-based MD3060e EMMs installed in place of the RAID controller modules. This configuration offers a maximum of 180 physical disks in your storage array with Premium Feature activation.

To connect the MD3060e-based expansion enclosure to your MD Series Dense storage array:

1. Connect a supported SAS cable to the SAS OUT port on the MD Series Dense storage array.
2. Connect the other end of the SAS cable to SAS port 1 on the MD3060e EMM as shown in the following figure.
3. To add a second MD3060e expansion enclosure, daisy chain it to the first expansion enclosure as shown in the diagram.

⚠ **CAUTION:** Do not connect to SAS port 2 on the EMM.

⚠ **CAUTION:** Like the RAID storage arrays, physical-disk slots 0, 3, 6, and 9 must be populated first.

⚠ **CAUTION:** The expansion enclosure must be direct-attached. Do not connect the MD3060e expansion enclosure to the MD Series Dense RAID storage array using a SAN connection.

NOTE: A maximum of two expansion enclosures are supported.

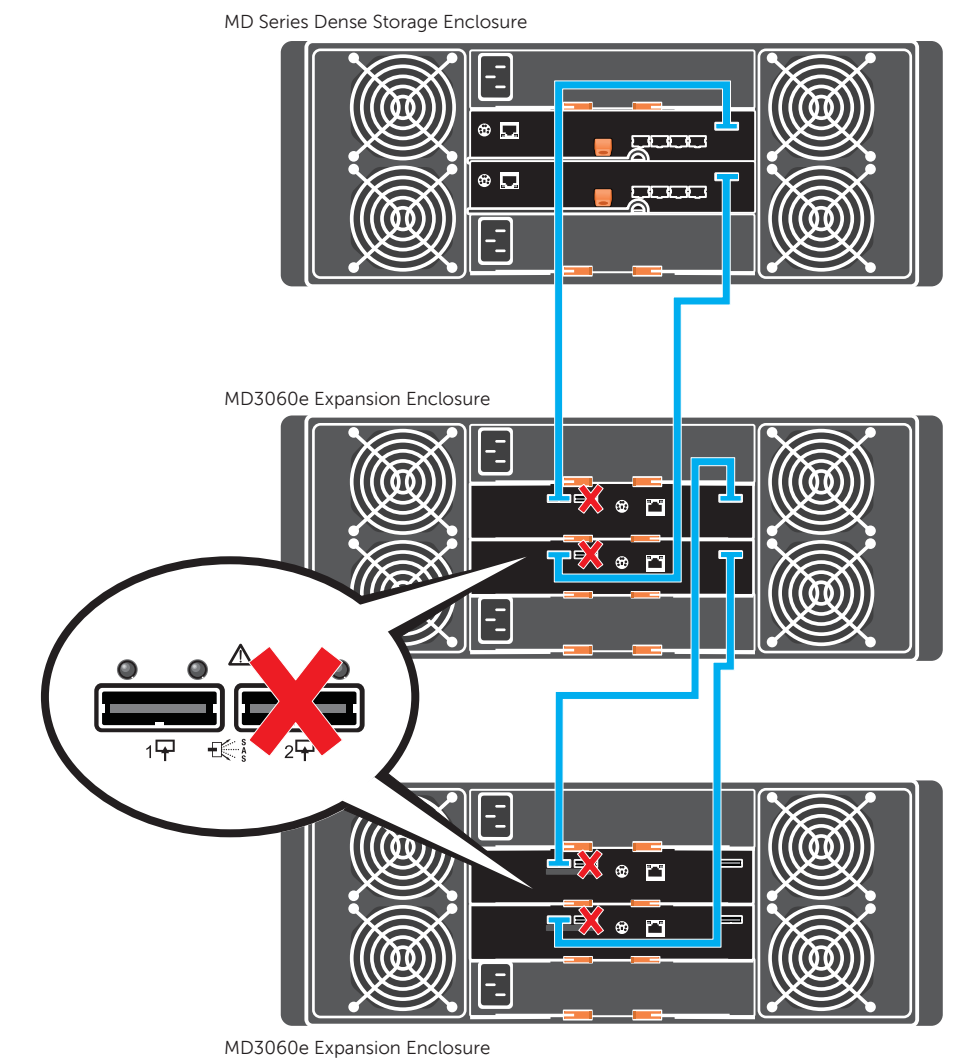

## Powering on the Storage Array

**WARNING:** Do not plug the enclosure into a standard power outlet. Your storage array is shipped with two IEC C19 to C20 jumper cords. Plug the C19 plug into the array's power supplies and the C20 plug into the power distribution unit (PDU) in the rack cabinet. For power redundancy, split the power connections from each enclosure into separate PDUs and connect the PDUs to external power receptacles on different circuits. The enclosure accepts only 200 V to 240 V input sources.

Follow these steps to power on your storage array:

1. Turn on any network switches, routers, or other standalone components.
2. Power on the MD3060e expansion enclosures, if applicable.

NOTE: Wait for the enclosure status LED to turn blue before proceeding to the next step.

3. Power on the MD Series Dense storage array.

NOTE: Wait for the storage array status LED to turn blue before attempting to discover or manage the array.

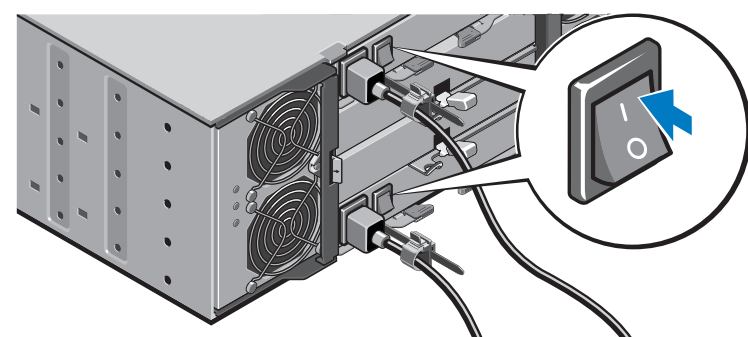

## Installing MD Storage Manager

The Dell PowerVault MD Series Resource DVD contains software and drivers for both Linux and Microsoft Windows operating systems. The DVD also contains MD Storage Manager, a graphically based utility, which is used to configure, manage, and monitor the storage array and expansion enclosures.

NOTE: If you are configuring an iSCSI storage array, use the MD Configuration Utility (MDCU) to set up iSCSI host ports and create iSCSI sessions. If you select the iSCSI management option from the Resource DVD, the MDCU is automatically launched when you start MD Storage Manager.

To install MD Storage Manager:

1. Insert the PowerVault MD Series Resource DVD.
2. If the installer does not launch automatically, go to the root directory on the DVD (or downloaded installer ISO) and double-click **md\_launcher.exe** (Windows) or use **auto run** (Linux).
3. Select **Install MD Storage Software**.

The installation wizard allows you to choose **Management Station** or **Host Installation**. You can choose both. You must, however, install the host-based storage agent and multipath drivers on each host server accessing the storage array.

### Review the Readme File

A **readme.txt** file is included in the Resource DVD root directory. It contains the latest updates, fixes, and other information applicable to your storage array.

## Discovering and Managing Your Storage Array

To discover your storage array, you must be connected to the Ethernet management port (either on the same subnet or through a configured network switch) on your RAID controller module. To run management operations, you must be connected to both RAID controller modules through a fully configured Ethernet management port.

NOTE: For best throughput, it is recommended that you use out-of-band management.

### Starting MD Storage Manager

To launch MD Storage Manager:

Select **Start** → **Programs** → **Dell** → **MD Storage Manager**.

The **Enterprise Management Window (EMW)** displays host servers and storage arrays automatically discovered on your local subnet.

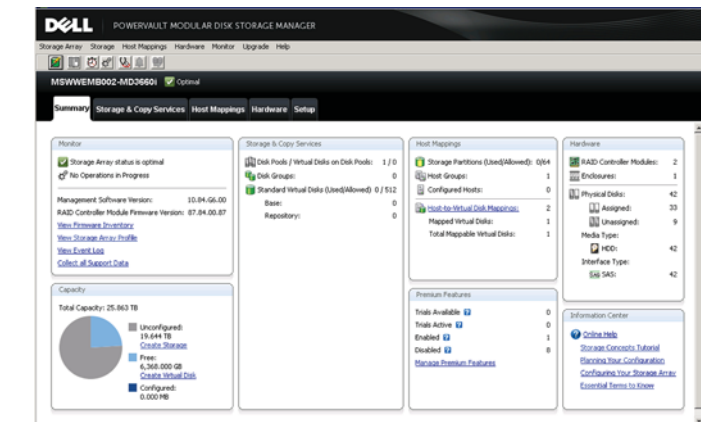
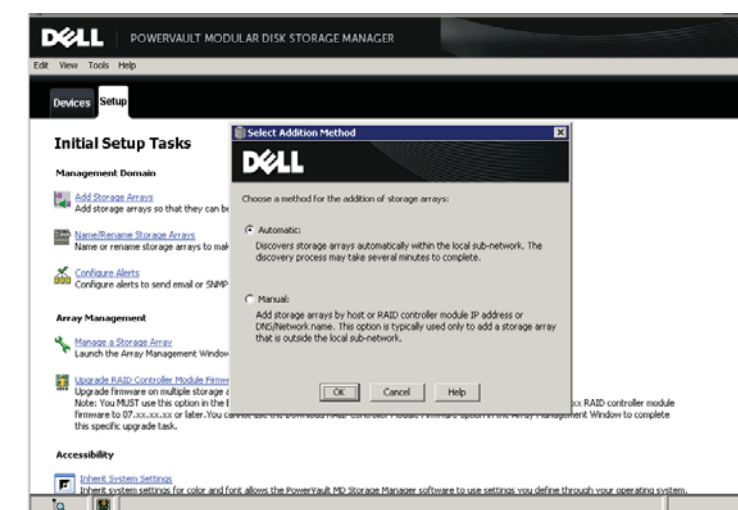

Using the Automatic Configuration Wizard

The **Automatic Configuration Wizard** allows you to create multiple disk groups, disk pools, virtual disks, and hot spare physical disks with the same attributes.

To start the wizard, select **Storage Array** → **Configuration** → **Automatic** → **Disk Pools** or **Disk Groups**.

Manually Configuring Storage Space

To manually configure your storage, select **Storage** → **Virtual Disk** → **Create**.

### Discovering Your Storage Array

1. In the EMW, click **Setup**.
2. Select **Add Storage Array**.
3. Choose either **Automatic** or **Manual** discovery.

NOTE: Automatic discovery discovers all storage arrays in your local subnet. Manual discovery prompts you to add storage arrays by IP address or network name.

4. Click **OK**.
5. Double-click the discovered storage array. The **Array Management Window** is displayed.

© 2012 Dell Inc. All rights reserved.

Dell™, the DELL logo, and PowerVault™ are trademarks of Dell Inc.



Printed in the U.S.A.

OJPG9TA00

2012 - 07